

Performance characteristics

- Operating frequency: 0.8~18GHz
- Gain: 24dB
- NF: 2.8dB
- P-1dB: 15dBm
- Outline Dimensions: 10x8x2.5mm

Principle diagram

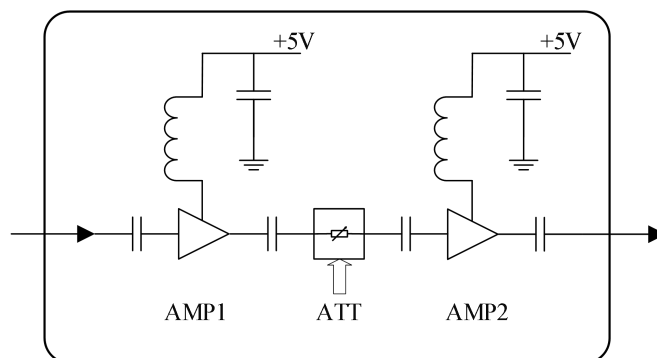

Product introduction

The GF038018Q2 programmable amplifier chip adopts GaAs technology, integrates an amplifier and a digital attenuator internally, with a frequency coverage range of 0.8-18GHz. It can not only achieve gain amplification but also gain adjustment, with an attenuation range of 0~31.5dB and a step of 0.5dB. The digital attenuation chip adopts 0/+5V voltage control and is housed in a ceramic package, suitable for SMT surface mount technology.

Absolute maximum ratings	
Parameter	Ratings
VDD	+5.5V
Input power	+20dBm
Operating temperature	-55~+85°C
Storage temperature	-55~+150°C
Note: Exceeding any of these limits may cause permanent damage.	

Electrical parameters(TA = +25°C, 50Ω system)

Parameter	Min	Typ	Max	Unit
Operating frequency	0.8		18	GHz
Gain		24		dB
Gain flatness		±1		dB
Noise figure		2.8		dB
Bit count		6		bit
Attenuation step		0.5		dB
Attenuation accuracy		±1		dB
Input return loss		-14		dB
Output return Loss		-13		dB
P-1dB		15		dBm
VDD current		90		mA
VEE current		10		mA

Main indicator testing curve

Gain VS. Frequency

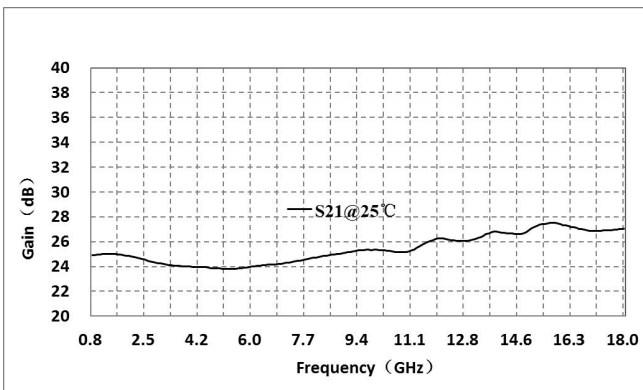

Noise figure VS. Frequency

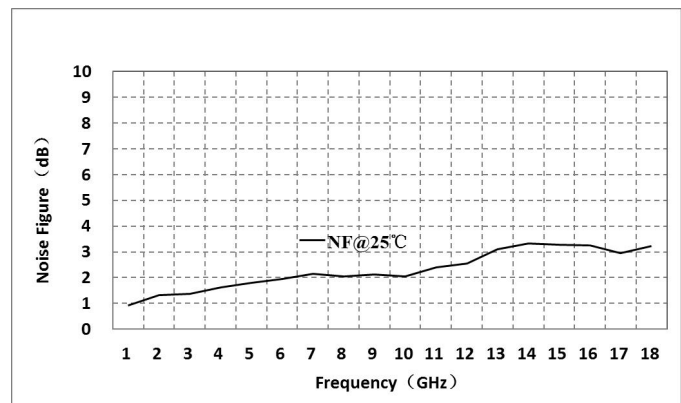

Input return loss VS. Frequency

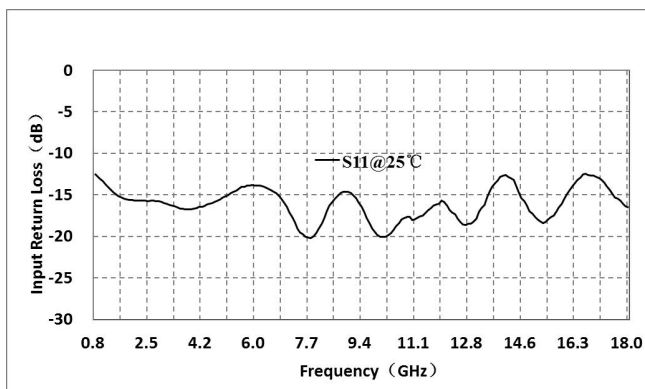

Output return loss VS. Frequency

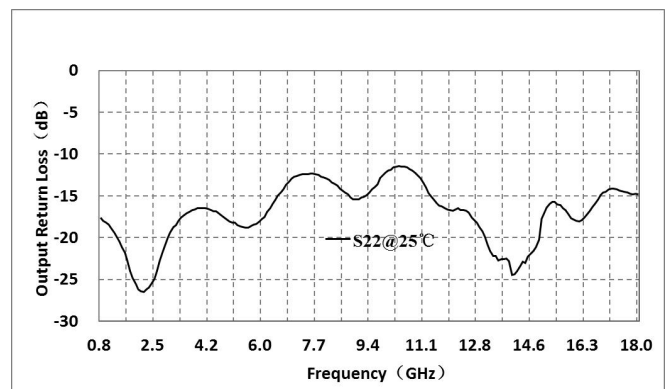

Programmable amplifier chip, 0.8~18GHz

Attenuation VS. Frequency

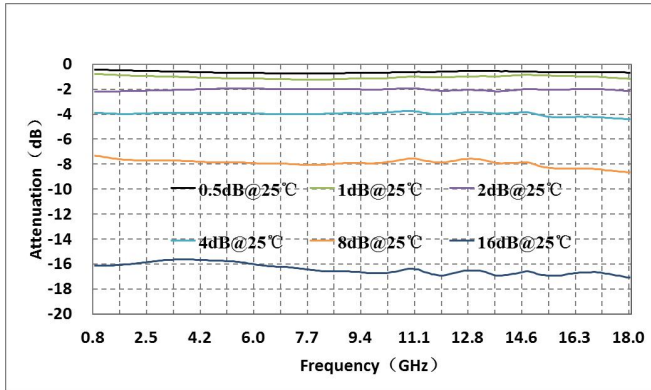

P-1 VS. Frequency

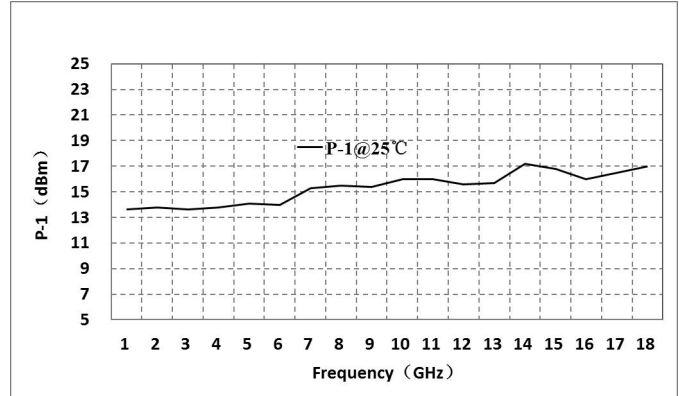

Isolation VS. Frequency

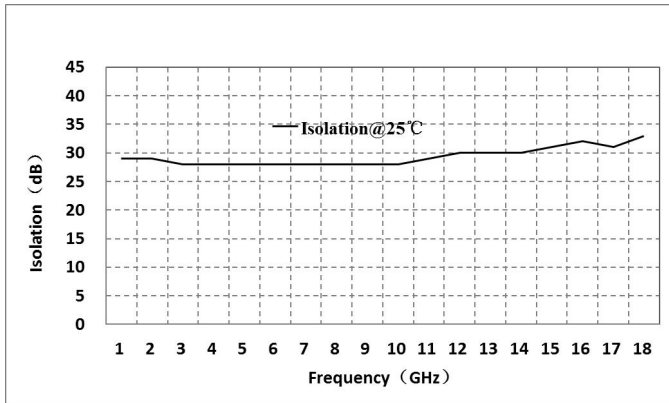

External structure

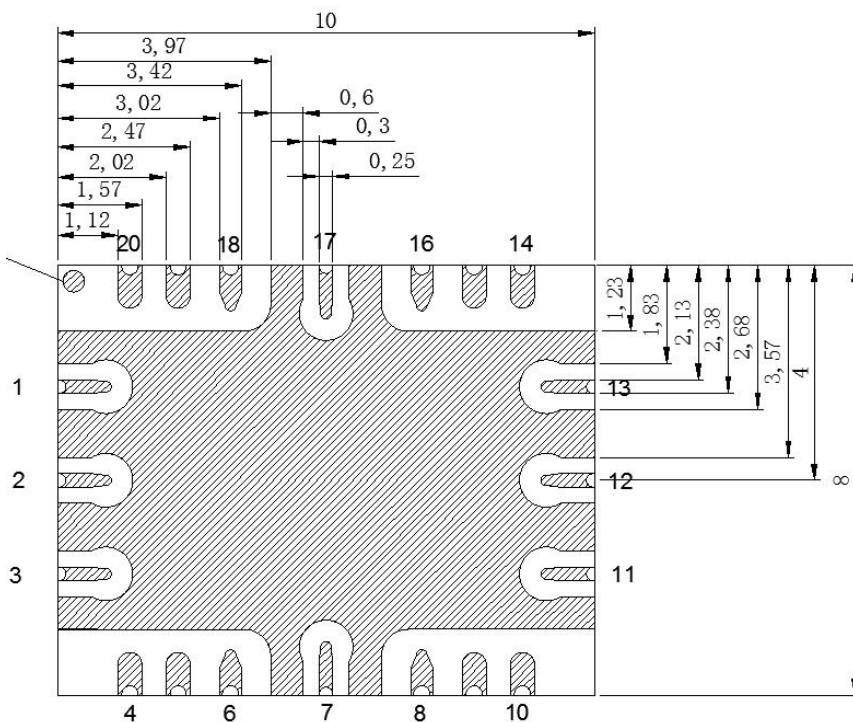

Programmable amplifier chip, 0.8~18GHz

Pin	Function	Description
1、13	VDD	+5V power supply
2	RFin	RF input, no need for blocking capacitors
3~11	GND	Ground
12	RFout	RF output, no need for blocking capacitors
14	0.5dB attenuation control bit A1	When A1=0, the 0.5dB attenuator is turned off, and when A1=5V, the 0.5dB attenuator is turned on
15	1dB attenuation control bit A2	When A2=0, the 1dB attenuator is turned off, and when A2=5V, the 1dB attenuator is turned on
16	2dB attenuation control bit A3	When A3=0, the 2dB attenuator is turned off, and when A3=5V, the 2dB attenuator is turned on
17	4dB attenuation control bit A4	When A4=0, the 4dB attenuator is turned off, and when A4=5V, the 4dB attenuator is turned on
18	8dB attenuation control bit A5	When A5=0, the 8dB attenuator is turned off, and when A5=5V, the 8dB attenuator is turned on
19	16dB attenuation control bit A6	When A6=0, the 16dB attenuator is turned off, and when A6=5V, the 16dB attenuator is turned on
20	VEE	This pin is a TTL level conversion circuit power port, connected to a -5V power supply

Truth table						
state	0.5dB	1dB	2dB	4dB	8dB	16dB
	A1	A2	A3	A4	A5	A6
reference	0	0	0	0	0	0
0.5dB	1	0	0	0	0	0
1dB	0	1	0	0	0	0
2dB	0	0	1	0	0	0
4dB	0	0	0	1	0	0
8dB	0	0	0	0	1	0
16dB	0	0	0	0	0	1

"0"level range: 0~0.8V; "1" Level range: 2.3~5V

Note:

- Unit: mm;
- It is recommended to connect a protective resistor of 1K ohms or more in series with the control input terminal;
- The device should be stored in a dry and nitrogen environment. When the device cannot be used up after being unpacked, it should be immediately stored in a drying oven or vacuum sealed to avoid absorbing moisture from the air;
- Devices are sensitive to static electricity, and attention should be paid to anti-static measures during storage, transportation, assembly, and use;

Programmable amplifier chip, 0.8~18GHz

- Please connect all grounding pins to RF ground;
- This product is suitable for reflow soldering installation process, with a maximum reflow soldering peak temperature of 260 °C.