

GaAs MMIC Reflective SP4T Switch Chip, DC- 8 GHz

Performance characteristics

- Frequency range: DC - 8 GHz
- Insertion loss : 1.3 dB type
- Isolation: 38 dB type
- On-state VSWR : 1.2
- Integrated logic control (all positive)
- 50Ohm input/output
- QFN3X3mm

Product Introduction

GSW-00084T-N-PD-PQ3 is a GaAs MMIC reflective single-pole four-throw switch chip, with 50Ω matching at the input/output end, a frequency range covering DC ~8 GHz , -5V power supply, 0V/+5V (compatible with +3.3V) positive level control, switching speed 20ns, 1dB compression input power + 27 dBm . The switch adopts a 3X3mm surface-mount leadless plastic package, and the surface of the pin pad is tinned, which is suitable for reflow soldering installation process.

Use restriction parameter ¹

Control voltage range	-0.5V ~ +6V
Supply voltage range	-6 V
Maximum input power	+33dBm
Operating temperature	-55 ~ +85°C
Storage temperature	-65 ~ +150°C

【1】 Exceeding any of these maximum limits may cause permanent damage.

Electrical performance parameters (TA = +25°C, VEE = -5V , VC = 0/+5V)

Index	Minimum	Typical Value	Maximum	Unit
Frequency Range	DC-8			GHz
Insertion loss	-	1.3	-	dB
Isolation	-	38	-	dB
On-state input return loss	-	20	-	dB
On-state output return loss	-	20	-	dB
P-1dB@1-4GHz	-	27	-	dBm
Switching speed	-	25	-	ns
Control high level	3	3.3	5	V
Control low level	0	-	0.5	V
Control current	-	-	1	mA

voltage	-	-5	-	V
Quiescent Current	-	10	-	mA

GaAs MMIC Reflective SP4T Switch Chip, DC- 8 GHz

Main index test curve

Insertion Loss vs. Operating Frequency

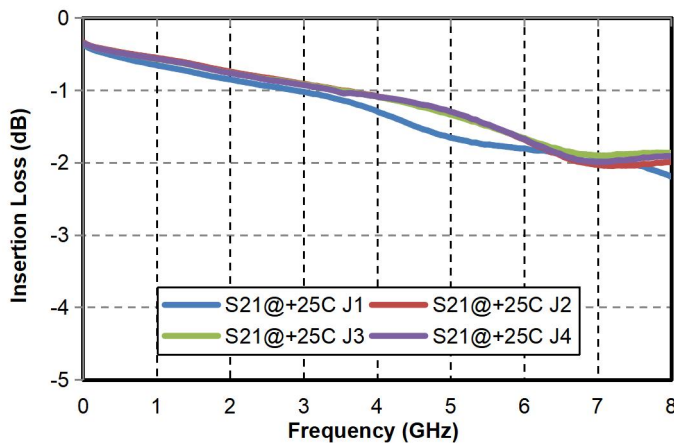

Isolation vs. Operating Frequency

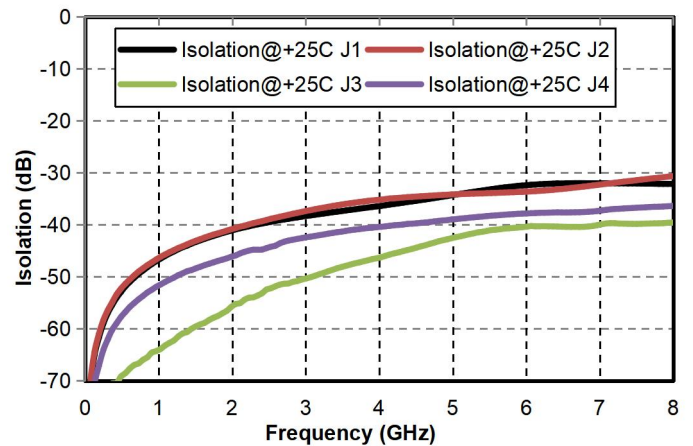

Input Return Loss vs. Operating Frequency (On State)

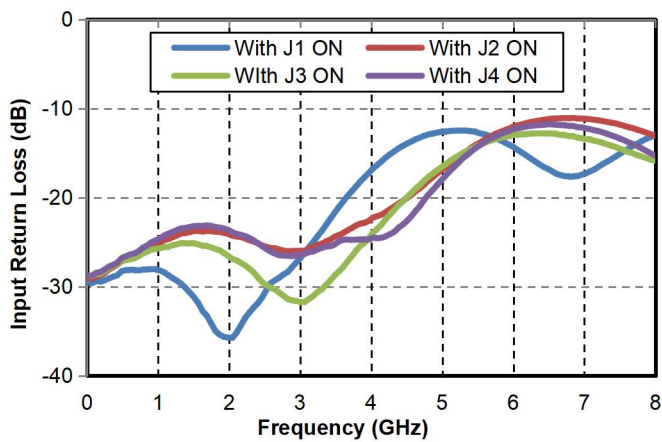

Output return loss vs. operating frequency (on state)

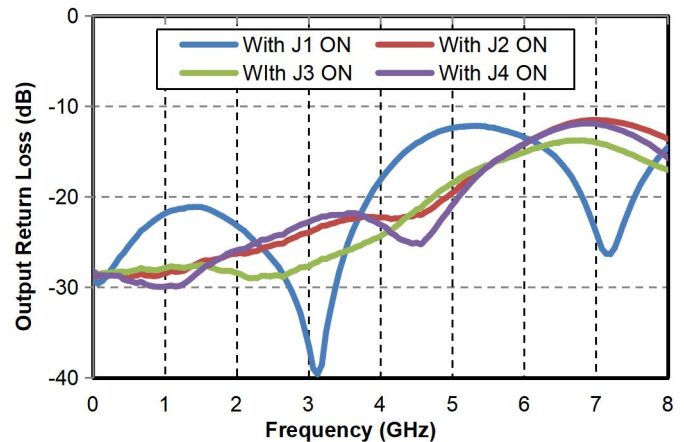

Appearance structure

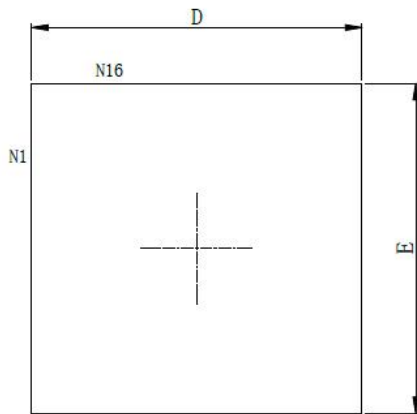

Top view

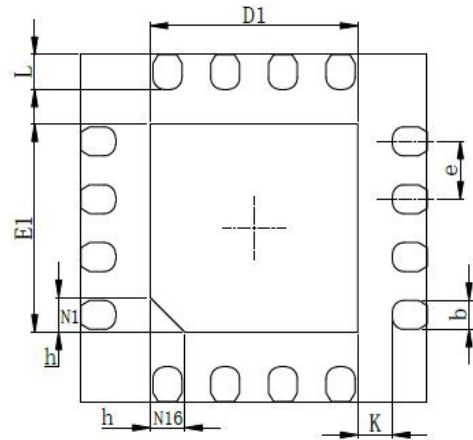

Bottom view

GaAs MMIC Reflective SP4T Switch Chip, DC- 8 GHz

Appearance structure

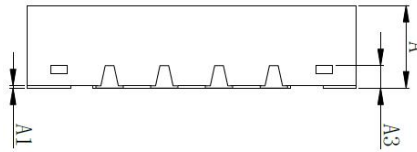

Side View

The units in the figures are all in millimeters , and the tolerance is ± 0.15 mm.

A	0.700	0.750	0.800
A1	0.000	0.020	0.05
A3	0.203 REF		
b	0.200	0.250	0.300
D	2.900	3.000	3.100
E	2.900	3.000	3.100
e	0.500 BSC.		
D1	1.700	1.800	1.900
E1	1.700	1.800	1.900
L	0.200	0.300	0.400
K	0.300 REF.		
h	0.300 REF.		

Truth Table

VEE	IN2	IN1	RFIN-RF1	RFIN-RF2	RFIN-RF3	RFIN-RF4
-5V	0V	0V	Conductivity	Shutdown	Shutdown	Shutdown
	0V	5V	Shutdown	Conductivity	Shutdown	Shutdown
	5V	0V	Shutdown	Shutdown	Conductivity	Shutdown
	5V	5V	Shutdown	Shutdown	Shutdown	Conductivity

Pin Definition

Pin number	Function Symbol	Functional Description
15	RFIN	RF signal input terminal, no DC blocking capacitor is integrated inside the chip
1, 4, 9, 12	RF OUT1/2/3/4	RF signal output terminal, no DC blocking capacitor is integrated inside the chip
7, 8	IN2, IN1	Positive level control port
6	VEE	voltage
Other pins and bottom of chip	GND	The bottom of the chip needs to be well grounded to RF and DC

GaAs MMIC Reflective SP4T Switch Chip, DC- 8 GHz

Application Circuit

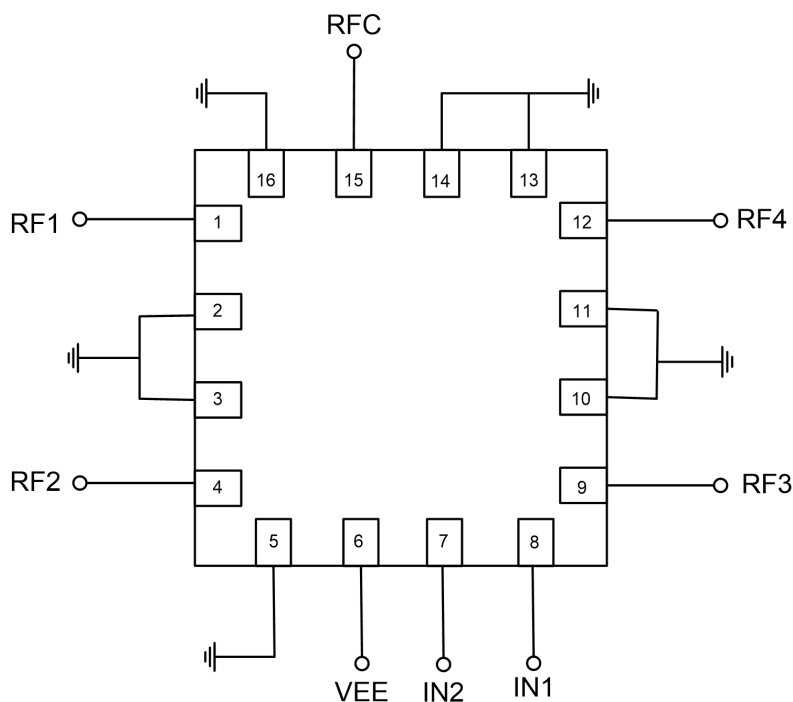

Precautions for use

- Sealing material : Low-pressure injection molding plastic that meets ROHS specifications
- Lead frame material: copper alloy
- Lead surface plating: 100% matte tin
- Maximum reflow peak temperature: 260 °C