

## GaAs MMIC Monolithic Integrated 0 Degree Triple Power Divider , 12-15 GHz

### Performance characteristics

- Frequency range: 12-15 GHz
- Insertion loss : 1.2 dB
- Isolation: 20dB
- Amplitude imbalance :  $\pm 0.1$  dB
- 50Ohm input / output
- Chip size: QFN 4X4

### Product Introduction

The GPD-12153-CQ4-1 monolithic integrated 0 -degree three-power divider has low insertion loss and good isolation in the frequency range of 12 ~ 15 GHz , and is very suitable for microwave hybrid integrated circuits and multi-chip modules. This chip adopts a 4 x 4 mm ceramic surface mount package, and the surface of the pin pad is tinned, which is suitable for reflow soldering installation process.

Use restriction parameter <sup>1</sup>	
Maximum input power	+40dBm
Operating temperature	-55 ~ +85°C
Storage temperature	-65 ~ +150°C

【1】 Exceeding any of these maximum limits may cause permanent damage.

Electrical performance parameters ( TA = +25°C)				
Index	Minimum	Typical Value	Maximum	Unit
Frequency Range	12-15			GHz
Insertion loss	-	1.2	-	dB
Insertion loss fluctuation	-	0.3	-	dB
Isolation	-	20	-	dB
Amplitude imbalance	-	$\pm 0.1$	-	dB
Input return loss	-	20	-	dB
Output return loss	-	12	-	dB

## GaAs MMIC Monolithic Integrated 0 Degree Triple Power Divider , 12-15 GHz

Main index test curve

Insertion Loss vs. Operating Frequency

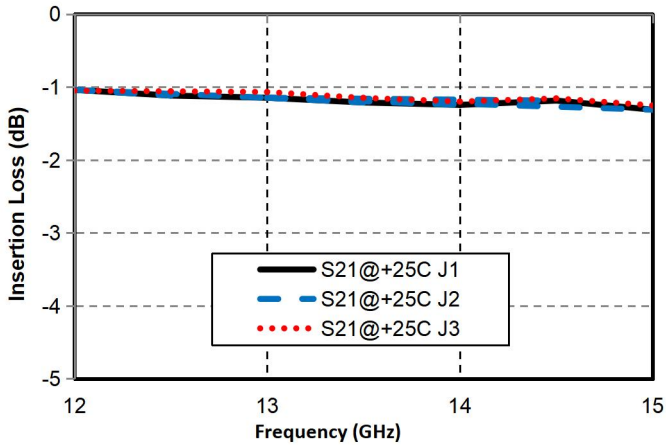

Isolation vs. Operating Frequency

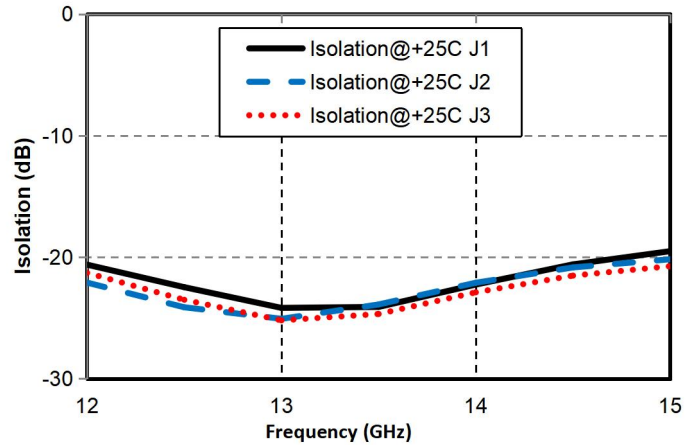

Input Return Loss vs. Operating Frequency

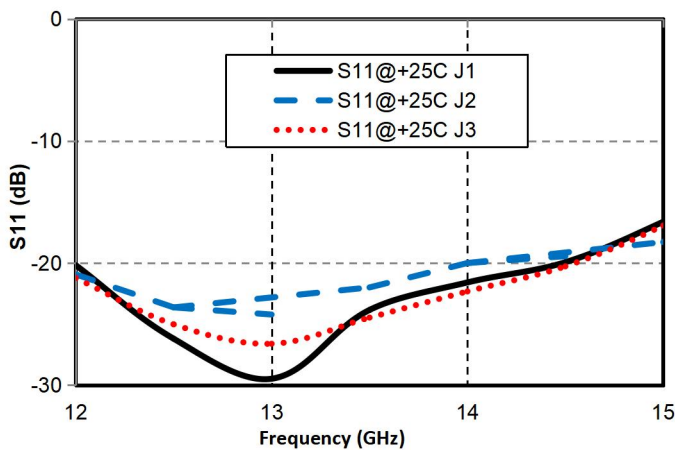

Output Return Loss vs. Operating Frequency

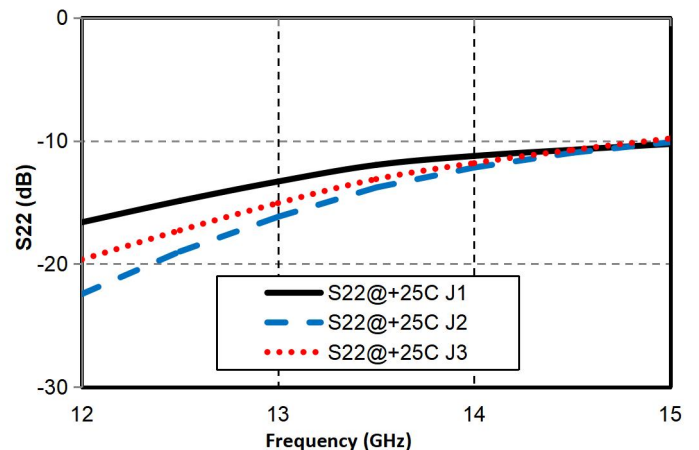

Appearance structure

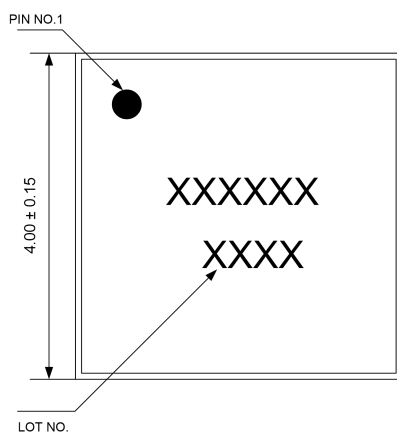

Top view

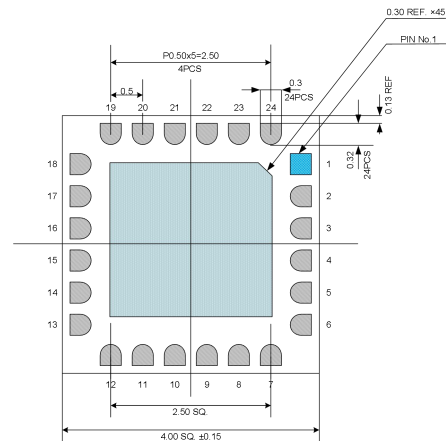

Bottom view

## GaAs MMIC Monolithic Integrated 0 Degree Power Divider , 12-15 GHz

Appearance structure

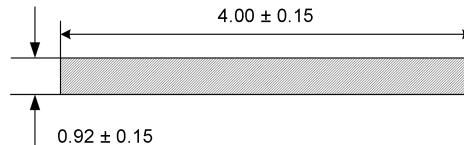

Side View

All units in the figures are millimeters .

Pin Definition		
Bonding point number	Function Symbol	Functional Description
3	RFIN	RF signal input terminal
10, 16, 21	RFOUT	RF signal output terminal
11, 15, 17, 20, 22	GND	The pins need to be well grounded to the RF and DC grounds
Chip bottom	GND	The bottom of the chip needs to be well grounded to RF and DC
Other	NC	The pin is floating and can be grounded

### Recommended Circuit

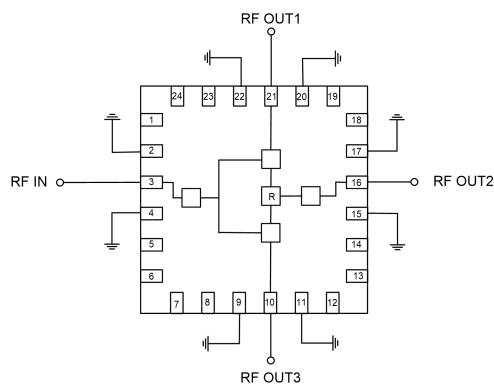

### Precautions for use

- Sealing material : Ceramic material that meets ROHS standards
- Lead frame material: copper alloy
- Lead surface plating: gold, gold layer thickness greater than 1.5um
- Maximum reflow peak temperature: 260 °C