

GaAs MMIC Monolithic Integrated 0 Degree Power Divider , 10-18GHz

Performance characteristics

- Frequency range: 10-18GHz
- Insertion loss : 0.5 dB
- Isolation: 26dB
- Standing wave: 1.2
- 50Ohm input / output
- Chip size: 0.96 x 0.78 x 0.1mm

Functional Block Diagram

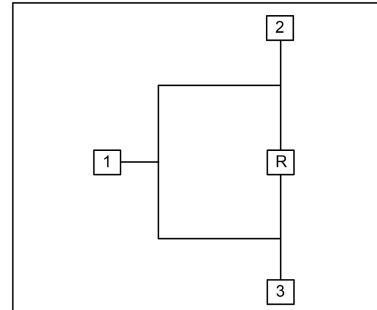

Product Introduction

GPD-1018A monolithic integrated 0 -degree power divider has low insertion loss and excellent port standing wave characteristics in the frequency range of 10~18GHz , with an isolation of 26dB , which is very suitable for microwave hybrid integrated circuits and multi-chip modules. The chip adopts on-chip through-hole metallization process to ensure good grounding, no additional grounding measures are required, and it is simple and convenient to use. The back of the chip is metallized and is suitable for eutectic sintering or conductive adhesive bonding process.

Use restriction parameter ¹

Maximum input power	+40dBm
Operating temperature	-55 ~ +85°C
storage temperature	-65 ~ +150°C

【1】 Exceeding any of these maximum limits may cause permanent damage.

Electrical performance parameters (TA = +25°C)

index	Minimum	Typical Value	Maximum	unit
Frequency Range	10-18			GHz
Insertion loss	-	0.5	0.7	dB
Insertion loss fluctuation	-	± 0.2	-	dB
Isolation	17	26	-	dB
Input return loss	-	24	-	dB
Output return loss	-	26	-	dB

GaAs MMIC Monolithic Integrated 0 Degree Power Divider , 10-18GHz

Main index test curve

Insertion Loss vs. Operating Frequency

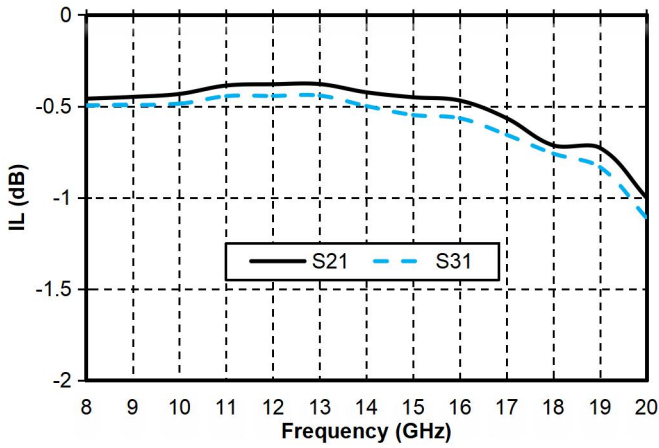

Isolation vs. Operating Frequency

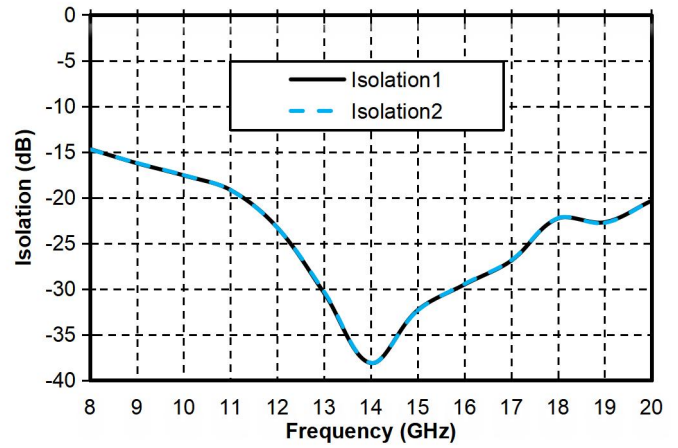

Input Return Loss vs. Operating Frequency

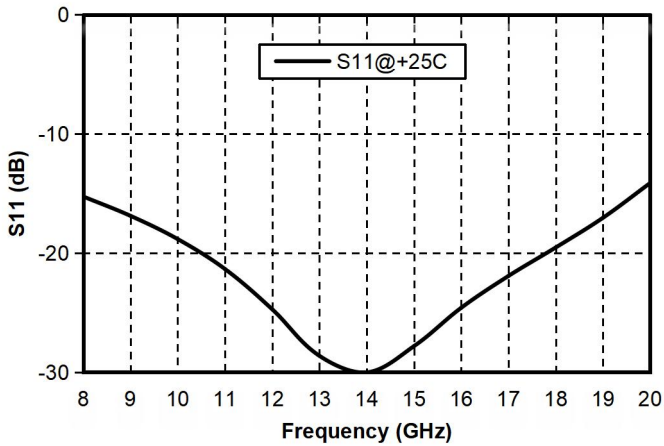

Output Return Loss vs. Operating Frequency

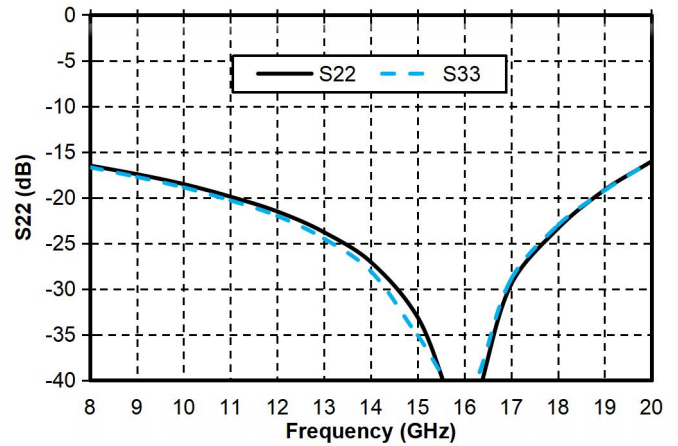

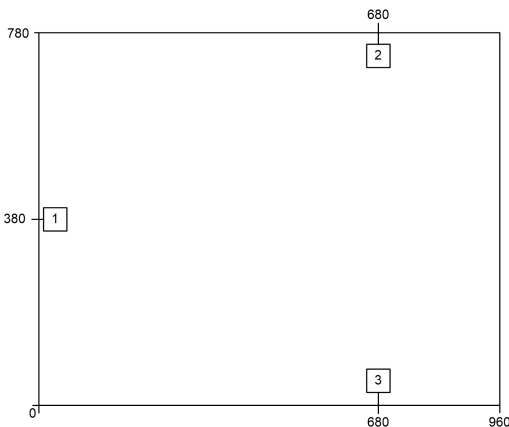

Appearance structure ²



【 2 】 The units in the figure are all micrometers (dimensional tolerance: ±100um.)

GaAs MMIC Monolithic Integrated 0 Degree Power Divider , 10-18GHz

Bonding point definition			
Bonding point number	Function Symbol	Functional Description	Equivalent Circuit
1	RF IN	RF signal input terminal	
2.3	RF OUT	RF signal output terminal	
Chip bottom	GND	The bottom of the chip needs to be well grounded to RF and DC	

Recommended assembly drawing

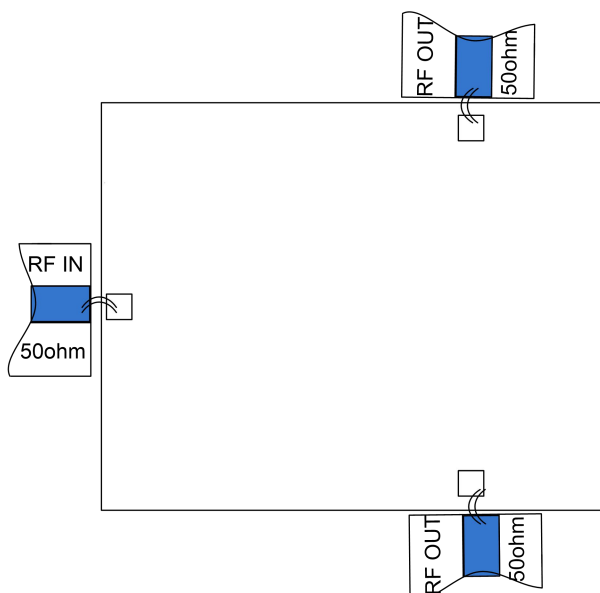

Precautions for use

- The chip needs to be stored in an anti-static container and kept in a nitrogen environment.
- bare die surface using wet chemical methods .
- Please strictly comply with ESD protection requirements to avoid electrostatic damage to bare chips.
- General operation: Please use precision pointed tweezers to pick up bare chips. Avoid touching the chip surface with tools or fingers during operation.
- Rack mounting operation suggestions: Bare chip mounting can be done by AuSn solder eutectic sintering or conductive adhesive bonding. The mounting surface must be clean and flat.
- Sintering process: It is recommended to use AuSn solder sheets with a gold -tin ratio of 80/20 . The working surface temperature reaches 255 °C and the tool (vacuum chuck) temperature reaches 265 °C. When the high-temperature mixed gas (nitrogen-hydrogen ratio of 90/10) is blown to the chip, the temperature at the top of the tool should be raised to 290 °C. Do not let the chip exceed 320 °C for more than 20 seconds. The friction time should not exceed 3 seconds.
- Bonding process: The amount of conductive glue dispensed should be as small as possible. After

the chip is placed in the installation position , the conductive glue should be vaguely visible around it . For curing conditions, please follow the information provided by the conductive glue manufacturer.

- Bonding operation suggestions: Use $\Phi 0.025\text{mm}$ (1mil) gold wire for both ball and wedge bonding . Thermo-ultrasonic bonding temperature is $150\text{ }^{\circ}\text{C}$. The pressure of the wedge for ball bonding is $40\sim 50\text{gf}$, and the pressure of the wedge bonding is $18\sim 22\text{gf}$. Use the smallest possible ultrasonic energy. The bonding starts at the pressure point on the chip and ends at the package (or substrate) .