

GaAs MMIC Power Amplifier Chip, 6-18 GHz

Performance characteristics

- Frequency range: 6 - 18 GHz
- Small signal gain: 17.5dB
- Gain flatness: ± 2.0 dB
- P -1 dB : 20dBm
- Psat : 20.5dBm
- Power supply: +5 V /130mA
- 50Ohm input / output
- Chip size: QFN 4X4

Block Diagram

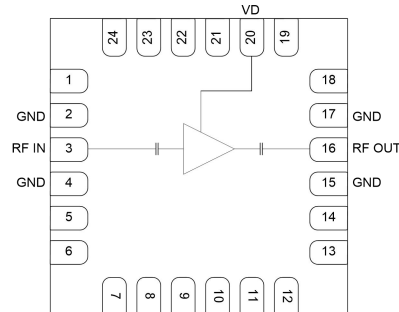

Product Introduction

GPA-0618-22-CQ4 is a broadband amplifier chip with a frequency range of 6GHz~18GHz, a small signal gain of 17.5dB, and a P-1 output of 20dBm. GPA-06180-22-CQ4 is powered by a single +5V power supply. This chip uses a 4 x 4 mm ceramic surface mount package to achieve airtight packaging. The surface of the pin pad is gold-plated and is suitable for reflow soldering installation.

Using the Limit Parameter

Maximum drain voltage	+7V
Maximum input power	+20dBm
Operating temperature	-55 ~ +85°C
Storage temperature	-65 ~ +150°C

Exceeding any of these maximum limits may cause permanent damage.

Electrical performance parameters (TA = +25°C , Vd = +5V)

Index	Minimum	Typical Value	Maximum	Unit
Frequency Range	6-18			GHz
Small Signal Gain	-	17.5	-	dB
Gain Flatness		± 2.0		dB
P -1dB	-	20	-	dBm
Psat	-	20.5	-	dBm
Input return loss	-	10	-	dB
Output return loss	-	15	-	dB
Quiescent Current		130		mA

GaAs MMIC Power Amplifier Chip, 6 - 18 GHz

Main index test curve

Gain vs. Frequency

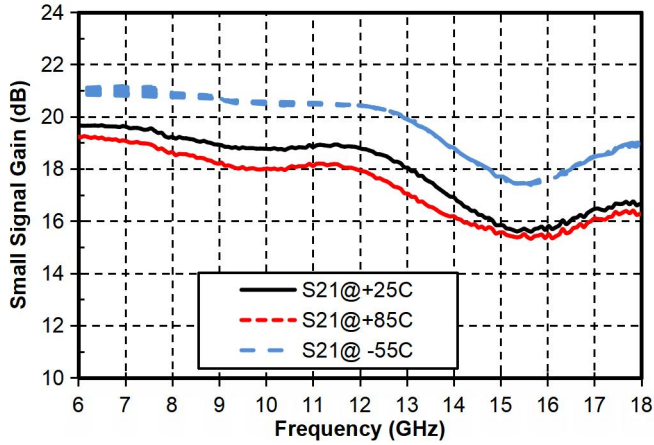

Reverse Isolation vs. Frequency

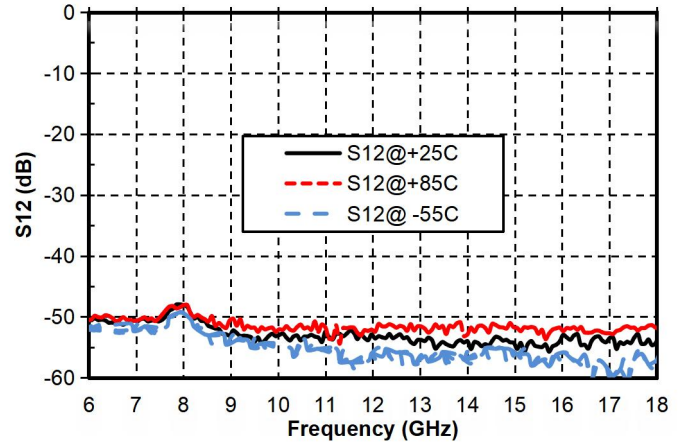

Input Return Loss vs. Frequency

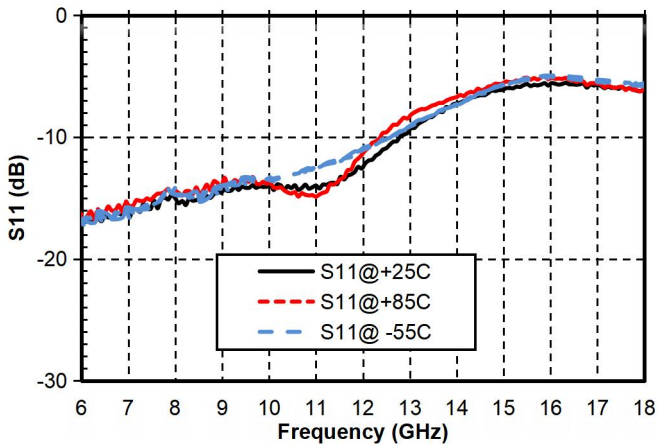

Output Return Loss vs. Frequency

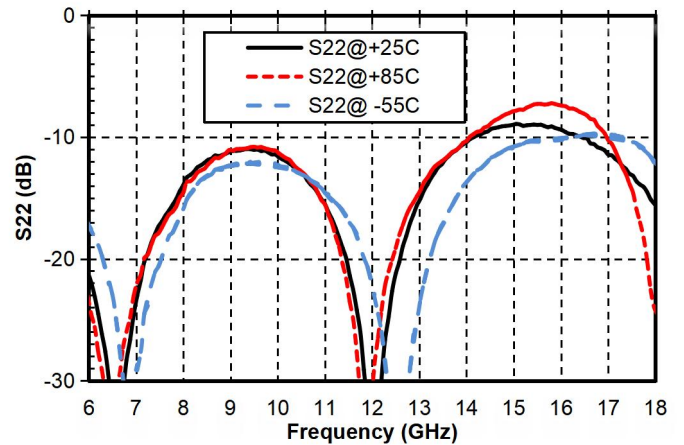

P-1dB vs. Frequency

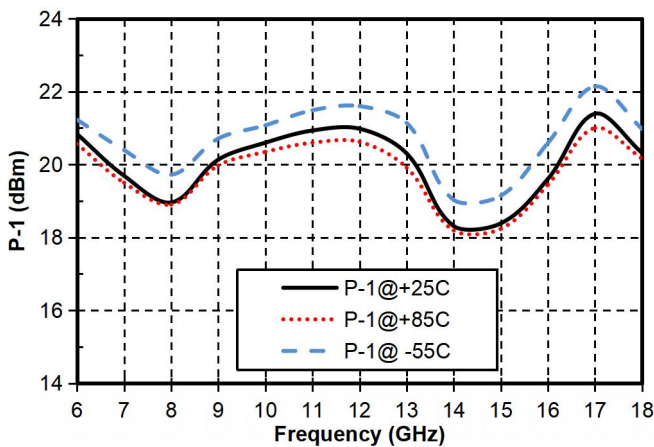

Psat vs. Frequency

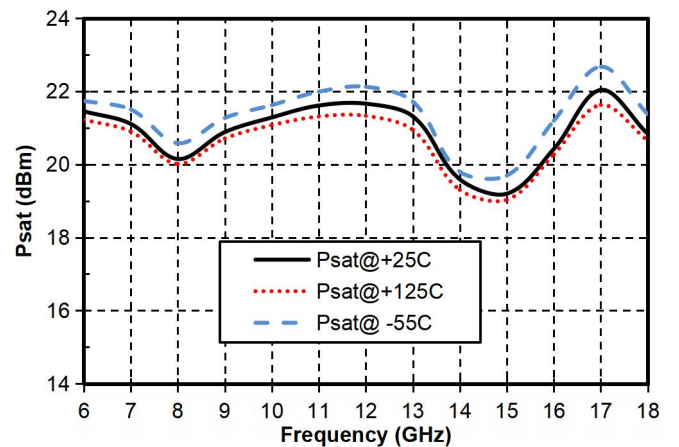

GaAs MMIC Power Amplifier Chip, 6 - 18 GHz

Appearance structure

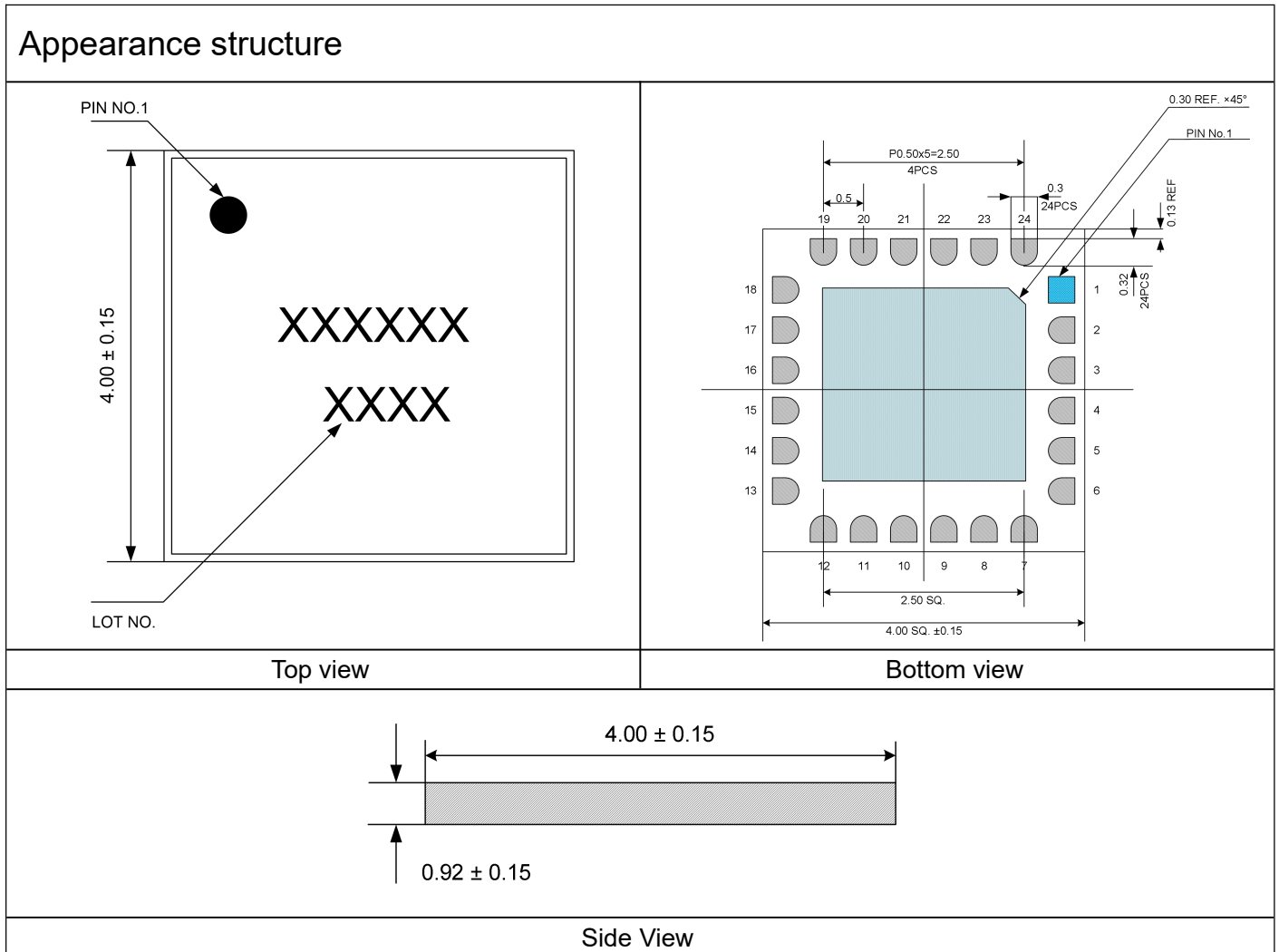

The units in the figures are all in millimeters , and the tolerance is ± 0.15 mm.

Pin Definition

Bonding point number	Function Symbol	Functional Description
3	RFIN	RF signal input terminal, no DC blocking capacitor required
16	RFOUT	RF signal output terminal, no DC blocking capacitor required
20	VDD	Amplifier Drain Bias
2, 4, 15, 17	GND	The pins need to be well grounded to the RF and DC grounds
Chip bottom	GND	The bottom of the chip needs to be well grounded to RF and DC
Other	NC	The pin is floating and can be grounded

GaAs MMIC Power Amplifier Chip, 6 - 18 GHz

Recommended Circuit

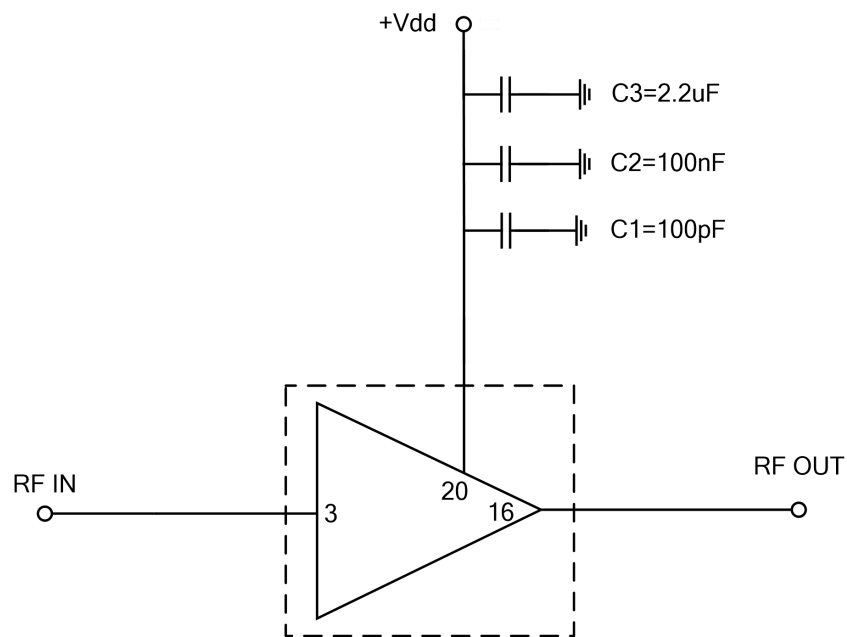

raw material	Capacitance, inductance, resistance
C1	100pF
C 2	100nF
C 3	2.2uF

Precautions for use

- Sealing material : Ceramic material that meets ROHS standards
- Lead frame material: copper alloy
- Lead surface plating: gold, gold layer thickness 0.30um MIN
- Maximum reflow peak temperature: 260 °C