

GaAs MMIC Limiter Chip, 0.5 - 4 GHz

Performance characteristics

- Frequency range: 0.5 - 4 GHz
- Insertion loss : 0.6 dB (Tpy .)
- Limiting level: 13dB m
- Power handling: 40dBm (CW)
- 50Ohm input / output
- Chip size: QFN 4X4

GLM-0004A-CQ4 is a GaAs MMIC limiter with a frequency range of 0.5~4 GHz , an insertion loss of 0.6 dB within the operating frequency band , and input and output wave 1. 2, anti-burning power 40dBm. The limiter adopts 4X4mm surface-mount leadless ceramic tube shell, which can achieve airtight packaging. The surface of the pin pad is plated gold process, suitable for reflow soldering installation process.

Electrical performance parameters (TA = +25°C)

Index	Minimum	Typical Value	Maximum	Unit
Frequency Range	0.5-4			G Hz
Insertion loss	-	0.6	-	dB
Input return loss	-	21		dB
Output return loss	-	22		dB
Clipping level	-	13	-	dBm
Anti-burning power	-	-	40	dBm

Main index test curve

Insertion Loss vs. Operating Frequency

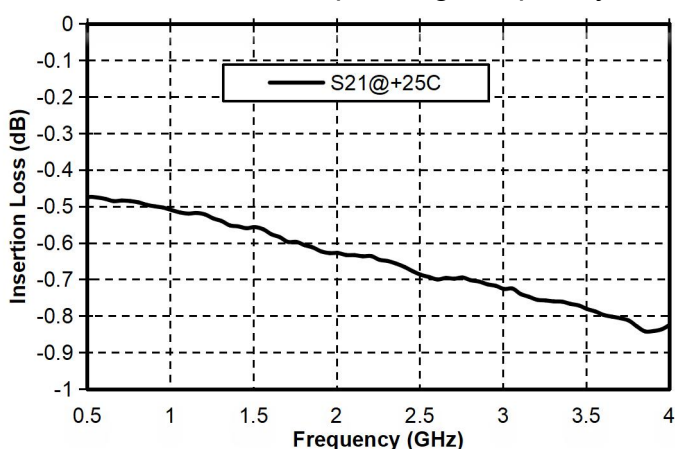

Input Standing Wave vs. Operating Frequency

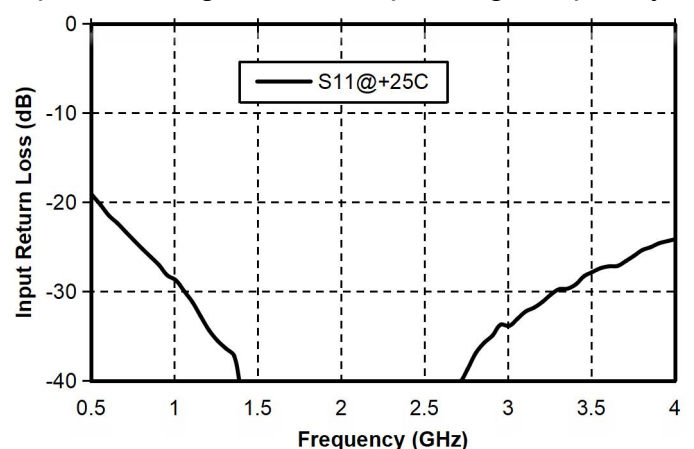

GaAs MMIC Limiter Chip, 0.5 - 4 GHz

Output Standing Wave vs. Operating Frequency

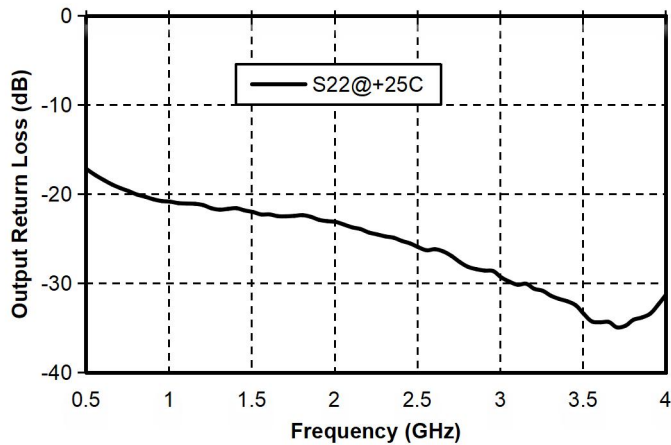

Clipping level@4GHz

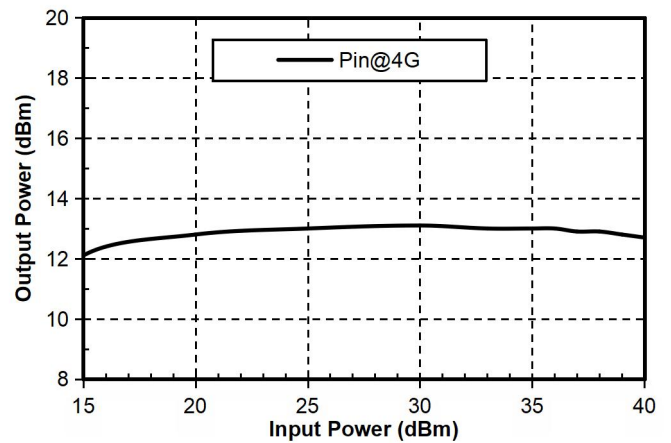

Appearance structure

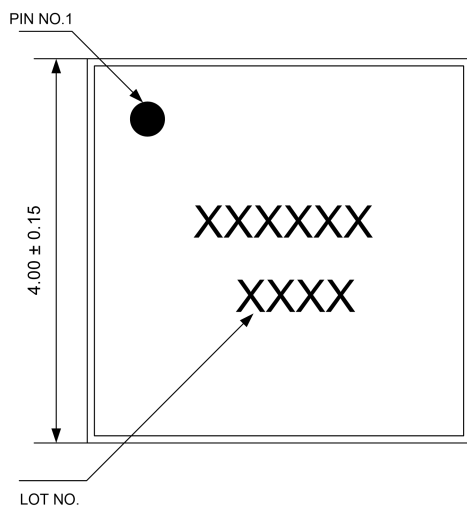

Top view

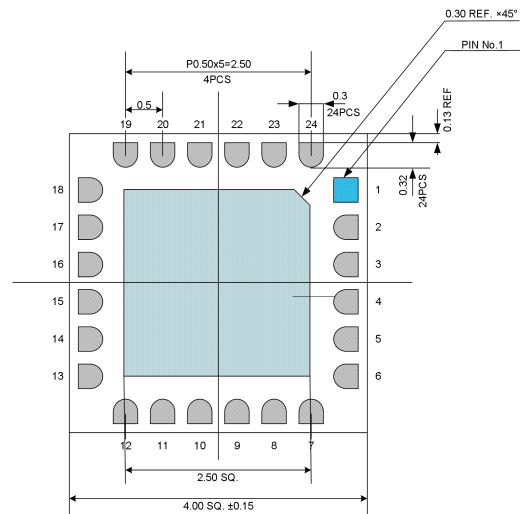

Bottom view

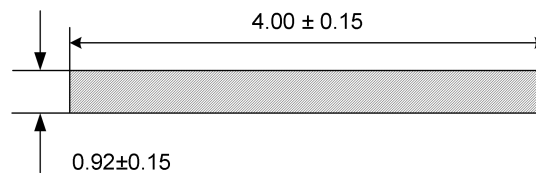

Side View

All units in the figures are millimeters .

GaAs MMIC Limiter Chip, 0.5 - 4 GHz

Recommended assembly drawing

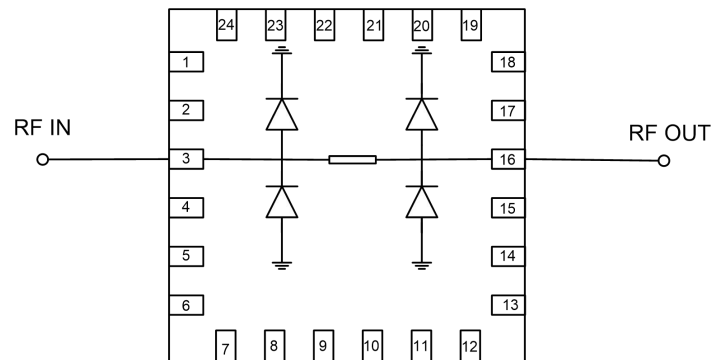

Pin Definition		
Pin number	Function Symbol	Functional Description
3	RFIN	RF signal input terminal. The chip input terminal does not integrate a DC blocking capacitor . It is recommended to connect an external DC blocking capacitor.
16	RFOUT	RF signal output terminal, the chip output terminal has integrated DC blocking capacitor
Chip bottom	GND	Needs to be in good contact with the RF and DC grounds
Other	NC	The pin is floating and can be grounded

Precautions for use

- Sealing material : Ceramic material that meets ROHS standards
- Lead frame material: copper alloy
- Lead surface plating: gold, gold layer thickness 0.30um MIN
- Maximum reflow peak temperature: 260 °C

Use limit parameters	
Maximum input power	+40dBm
Operating temperature	-55 ~ + 125 °C
Storage temperature	-65 ~ +150°C

Exceeding any of these maximum limits may cause permanent damage.