

GaAs MMIC Low Noise Amplifier Chip, 24-40GHz

Performance characteristics

- Frequency range:24-40GHz
- Small signal gain:21.5dB
- Noise figure:2.0dB typ. / 2.2dB max.
- P-1dB: 10.5dBm
- Power supply: +5V/42mA
- Input/Output: 50Ohm
- 100% on-chip testing
- Chip size:1.6 x 0.95 x 0.09 mm

Functional Block Diagram

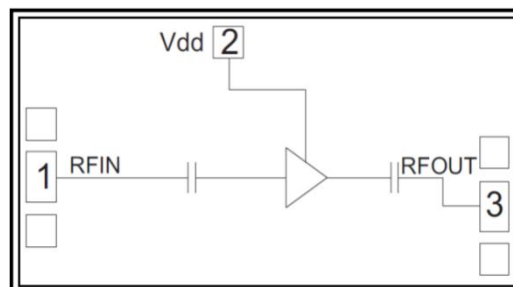

Product Introduction

GLA-2440 is a broadband low-noise amplifier chip, with a frequency range of 24GHz~40GHz, a small signal gain of 21.5dB, and an in band noise figure of 2.0dB. GLA-2440 is powered by a +5V single power supply.

Use restriction parameters ¹	
Maximum leakage voltage	+7V
Maximum input power	+20dBm
Working temperature	-55 ~ +85°C
Storage temperature	-65 ~ +150°C

【1】 Exceeding any of the above maximum limits may result in permanent damage.

Electrical performance parameters($T_A = +25^\circ\text{C}$, $V_d = +5\text{V}$)				
Index	Minimum value	Typical value	Maximum value	Unit
Frequency range	24-40			GHz
Small signal gain	20.5	21.5	24.5	dB
Gain flatness		± 2.0		dB
Noise figure	1.5	2.0	2.2	dB
P-1dB	9	10.5	11.5	dBm
Psat	11	11.5	12	dBm
Input return loss	9	12	-	dB
Output return Loss	14	16	-	dB
Static current		42		mA

GaAs MMIC Low Noise Amplifier Chip, 24-40GHz

Main indicator testing curve

Gain vs. Temperature

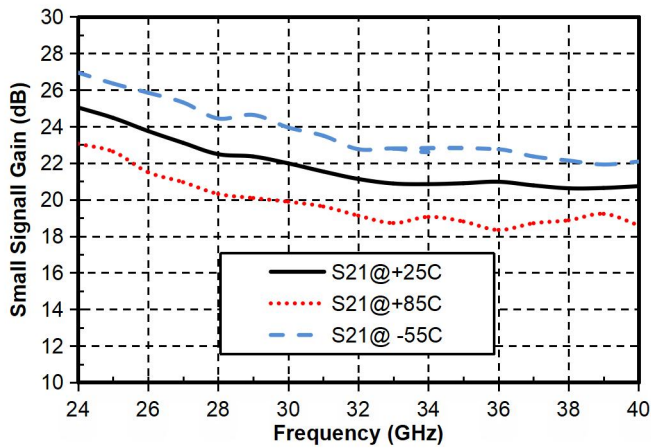

Noise Figure vs. Temperature

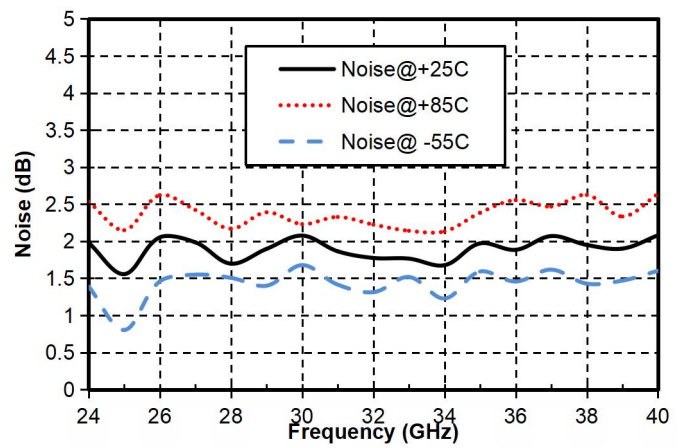

Input return loss vs. Frequency

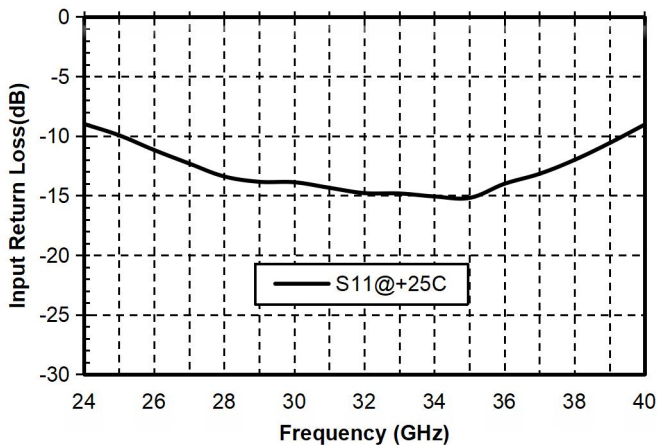

Output return Loss vs. Frequency

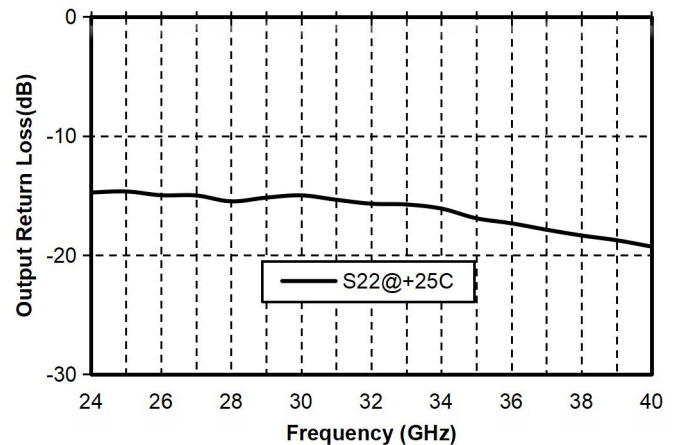

Reverse isolation vs. Frequency

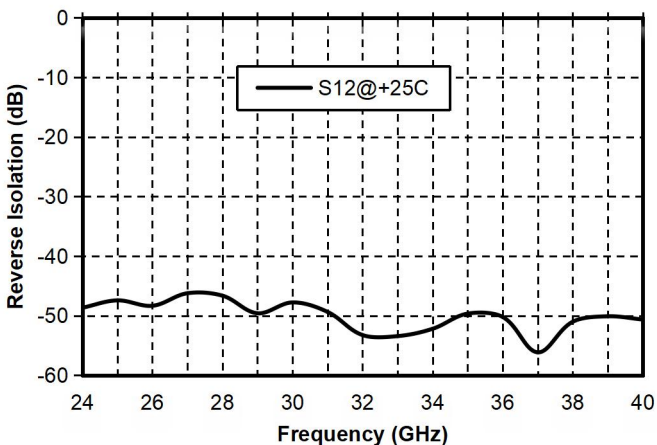

P-1dB, Psat vs. Frequency

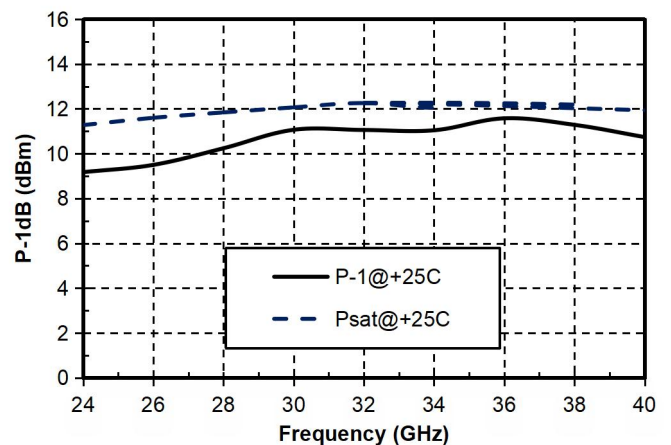



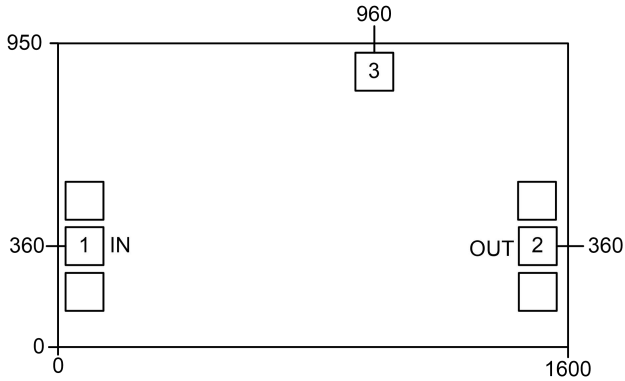

GaAs MMIC Low Noise Amplifier Chip, 24-40GHz

External structure²

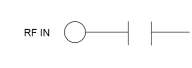

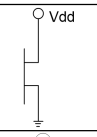
【2】 The units in the figure are all millimeters.

Definition of bonding pressure point			
Bond point number	Functional symbols	Function Description	Equivalent circuit
1	RFIN	RF signal input terminal, no need for DC capacitors.	
2	RFOUT	RF signal output terminal, no need for DC isolation capacitor.	
3	Vd	Amplifier drain bias, requires an external 100pF bypass capacitor.	
Chip bottom	GND	The bottom of the chip needs to be well grounded with RF and DC.	

GaAs MMIC Low Noise Amplifier Chip, 24-40GHz

Recommended assembly diagram

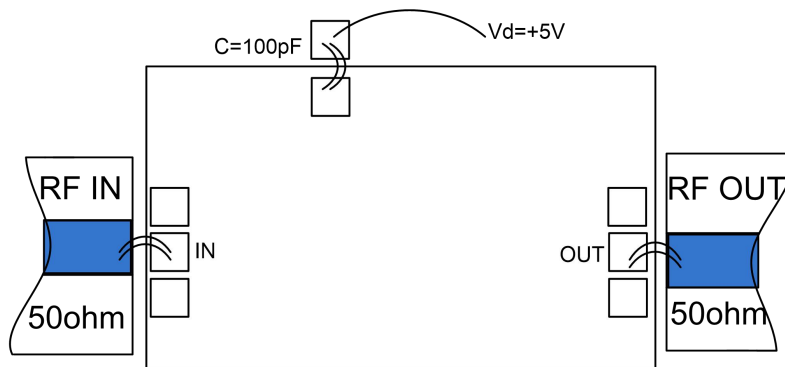

Notice

- The chip needs to be stored in a container with anti-static function and stored in a nitrogen environment.
- Attempting to clean the surface of bare chips using wet chemical methods is prohibited.
- Please strictly comply with ESD protection requirements to avoid static damage to bare chips.
- Routine operation: Please use precision pointed tweezers to remove the bare chip. During the operation, avoid tools or fingers touching the surface of the chip.
- Suggestion for mounting operation: Bare chip installation can use AuSn solder eutectic sintering or conductive adhesive bonding process. The installation surface must be clean and flat.
- Sintering process: It is recommended to use AuSn solder sheets with a gold tin ratio of 80/20. The working surface temperature reached 255 °C, and the tool (vacuum chuck) temperature reached 265 °C. When a high-temperature mixed gas (nitrogen to hydrogen ratio of 90/10) is blown onto the chip, the temperature at the top of the tool should be raised to 290 °C. Do not let the chip stay above 320 °C for more than 20 seconds. The friction time should not exceed 3 seconds.
- Bonding process: The amount of conductive adhesive applied should be as small as possible. After placing the chip in the installation position, the conductive adhesive can be vaguely visible around it. Please follow the information provided by the conductive adhesive manufacturer for curing conditions.
- Suggestion for bonding operation: Both spherical or wedge-shaped bonding should be used Φ 0.025mm (1mil) gold wire. Thermal ultrasonic bonding temperature is 150 °C. The pressure of the spherical bonding cutter is 40-50GF, and the pressure of the wedge bonding cutter is 18-22GF. Use as little ultrasonic energy as possible. The bonding process starts at the pressing point on the chip and ends at the packaging (or substrate).